

SCM Series

Common Mode Filter

Size 1210

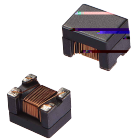

FEATURES

- High self-resonance frequency enables high cut-off frequency, wide band noise suppress in high frequency.
- Small size and low profile.
- Operating temperature $-40\sim+125^{\circ}\text{C}$ (Including self - temperature rise)
- Small size and low profile.
- Quantity: 3000pcs

APPLICATIONS

- USB 3.0 lines
- AV interfaces, such as HDMI 1.3/1/4
- High-speed signal lines

Dimensions: [mm]

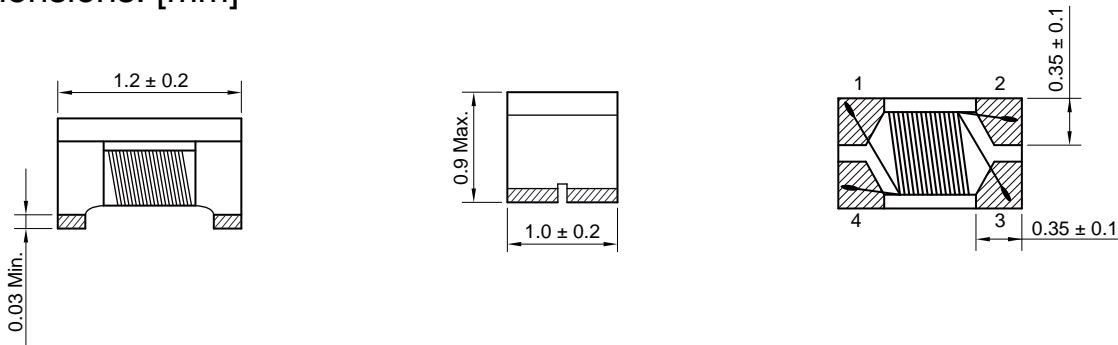

Schematic:

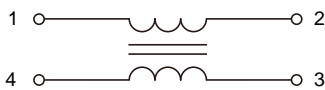

Land Pattern: [mm]

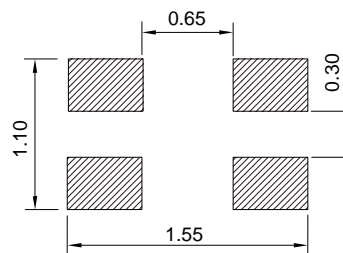

Electrical Properties:

Part No	Impedance @ 100 MHz	Tolerance	DC Resistance Max.	Rated Current Max.	Rated Volt	Withstand Volt	IR Min.

Typical Electrical Characteristics:

Impedance VS Frequency

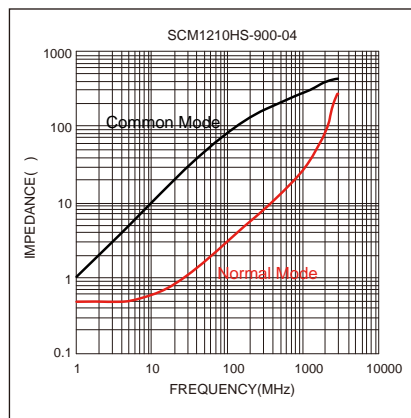
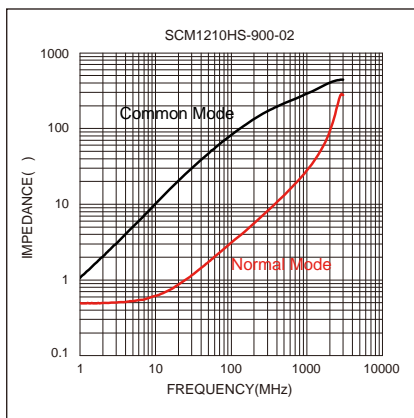
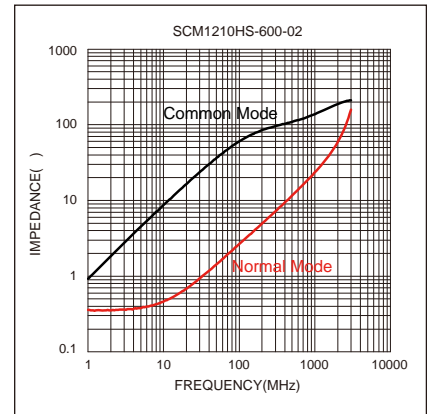
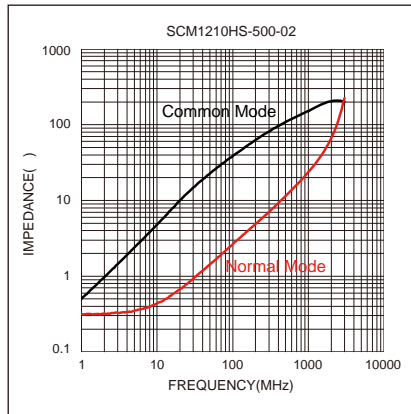
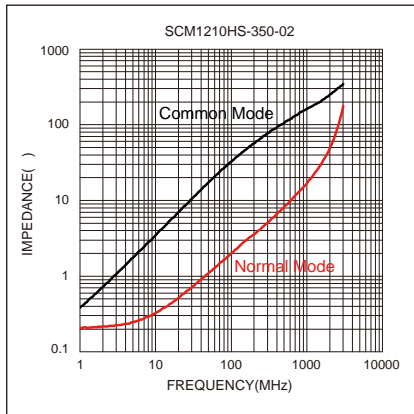

Attenuation VS Frequency

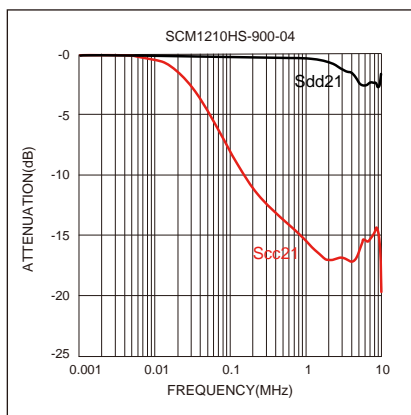
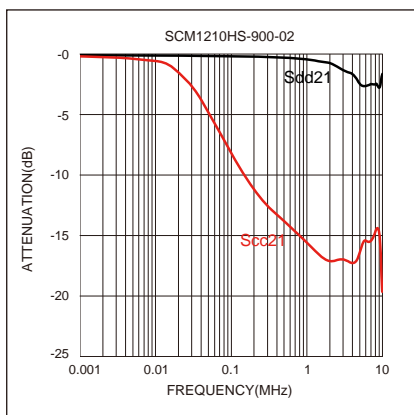
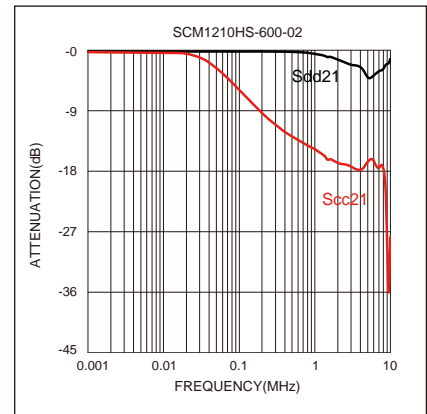
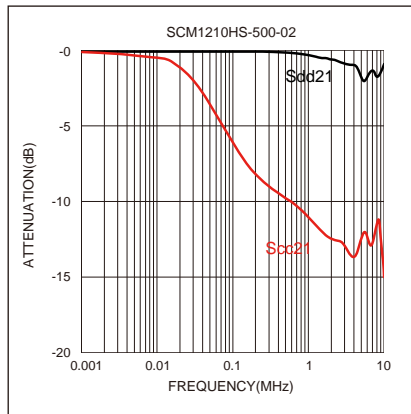
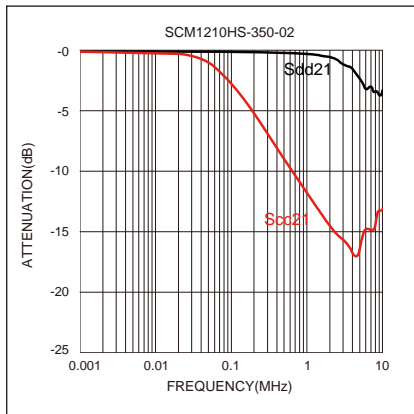

Soldering Reflow:

Preheat condition: 150 ~200°C / 60~180 sec.

Allowed time above 217°C : 60~150 sec.: 60~150 sec.

Packaging Information:

Tape Dimension:

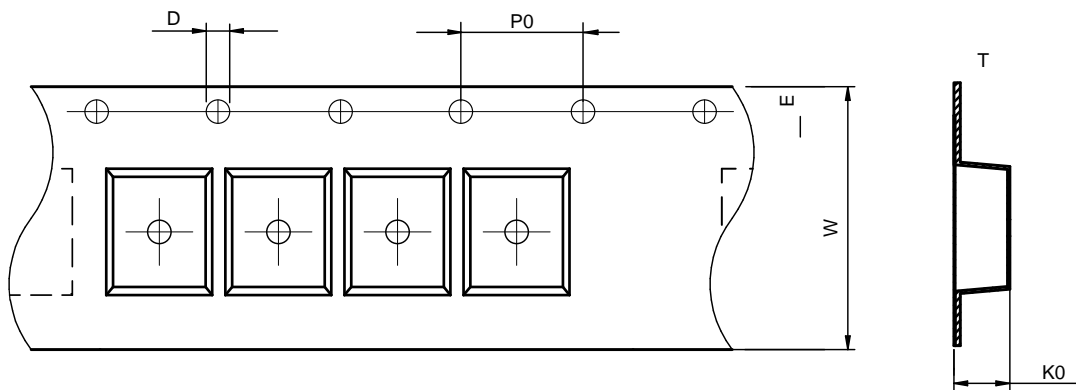

Series	A0 (mm)	B0 (mm)	D (mm)	P0 (mm)	P1 (mm)	W (mm)	K0 (mm)	E (mm)	T (mm)
SCM1210HS	1.12 ± 0.1	1.40 ± 0.1	1.5 ± 0.1	4.0 ± 0.1	4.0 ± 0.1	8.0 ± 0.3	1.05 ± 0.1	1.75 ± 0.1	0.22 ± 0.05

Peel force of top cover tape:

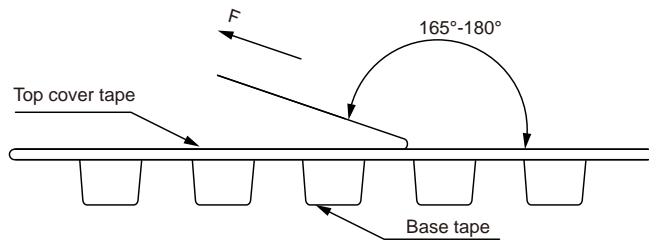

The peel force of top cover tape shall be between 0.15 to 0.78 N

Reel Dimension: [mm]

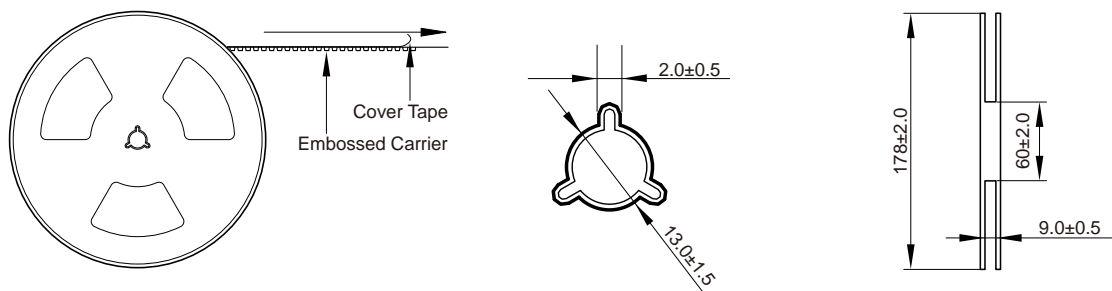

Packaging Quantity:

