

-
-
-
-
-
-
-
-

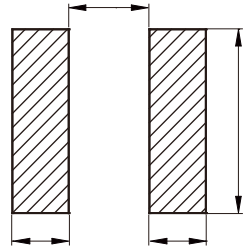

	(μ H)		Satura on (A)	(A)	(m)	(MHZ)
						53
	3.3					
	4.7					
						9
	33					
	47					7
						5
						4

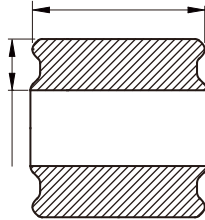

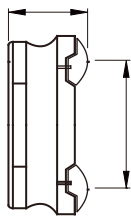
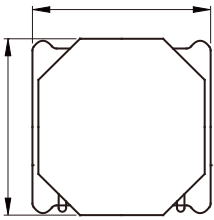
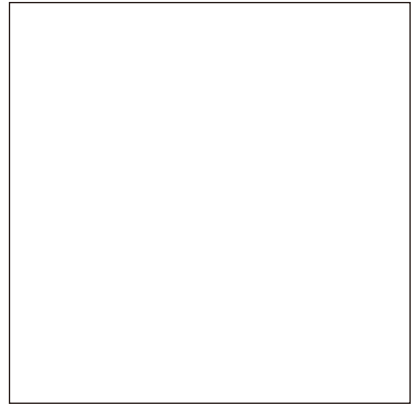
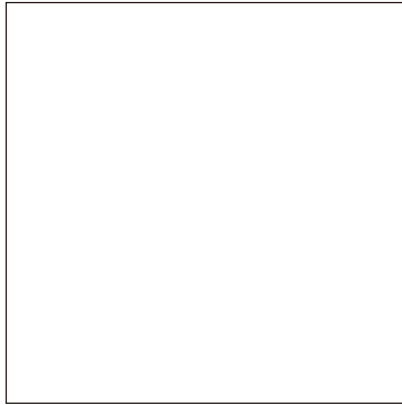
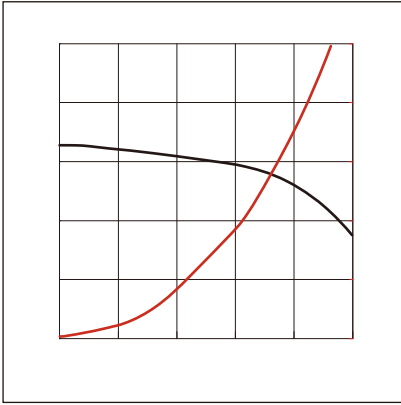

C
C
C

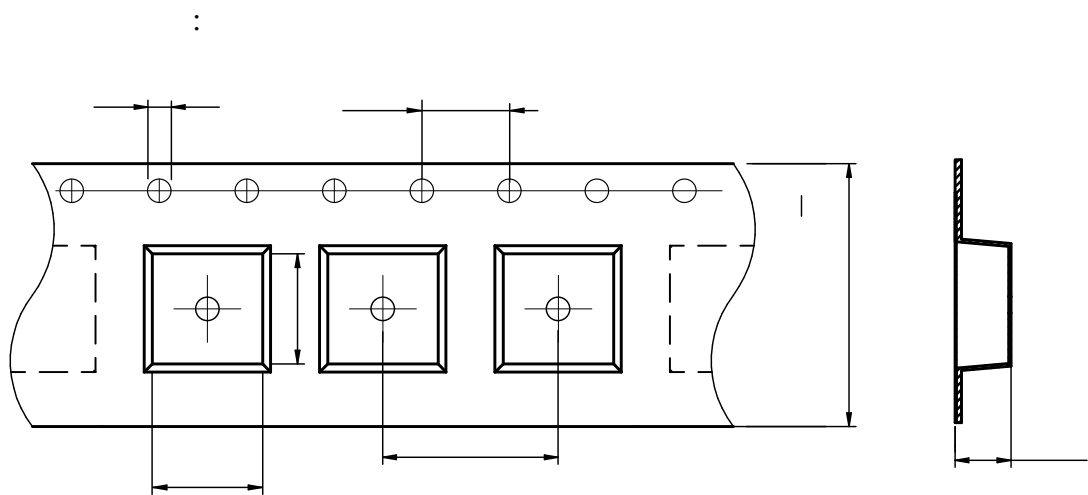

NRSA6028	6.4±0.1	6.4±0.1	1.5±0.1	4.0±0.1	8.0±0.1	16.0±0.3	3.3±0.1	1.75±0.1	0.40±0.03

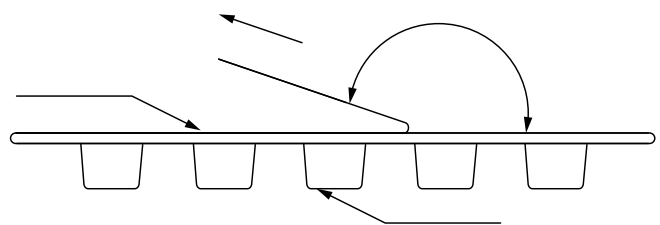

The peel force of top cover tape shall be between 0.3 to 1.17 N

