

MDTE Series

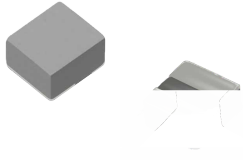

FEATURES

-
-
-
-
-
-
-

°C

APPLICATION

-
-

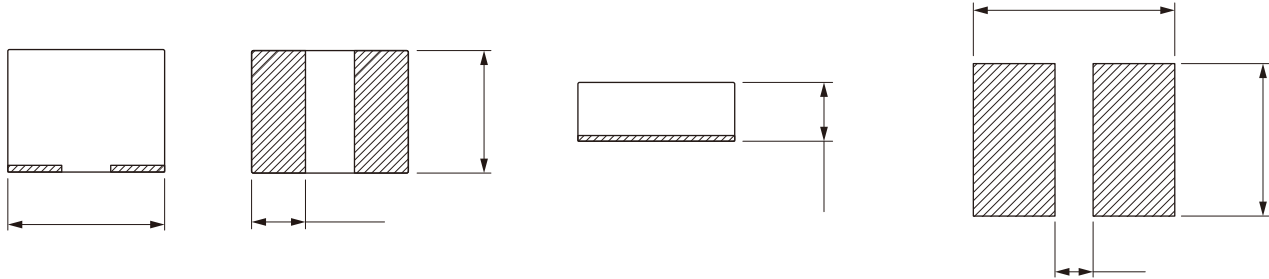

Part No	Inductance @ 1MHz/1V	Tolerance	Current Typ.	Current Max.	Temperature Rise Current Typ.	Temperature Rise Current Max.	DC Resistance Max.



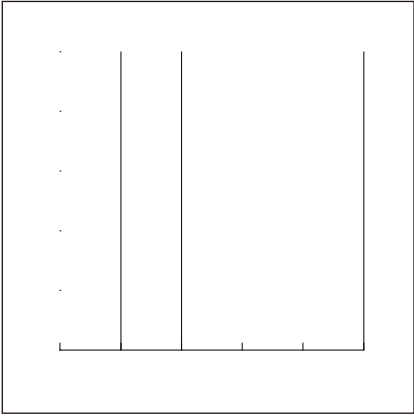

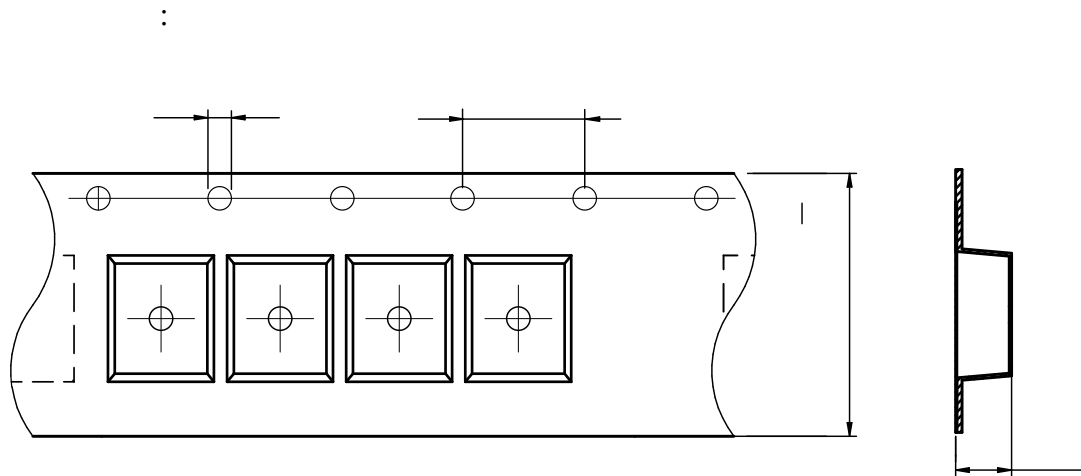

MDTE141208	1.5±0.1	1.7±0.1	1.5±0.1	4.0±0.1	4.0±0.1	8.0±0.1	1.0±0.1	1.75±0.1	0.25±0.05

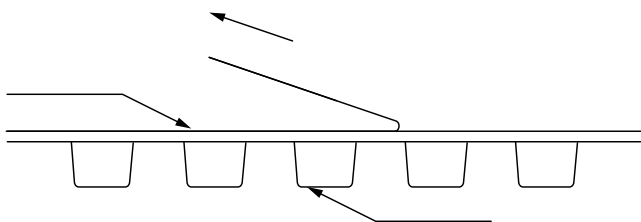

The peel force of top cover tape shall be between 0.1 to 0.98 N

:

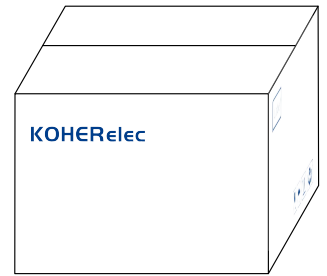
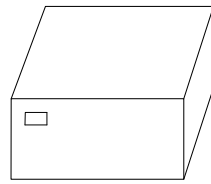
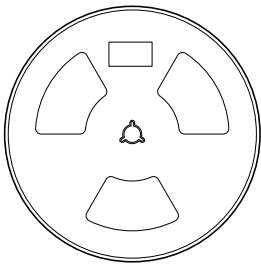
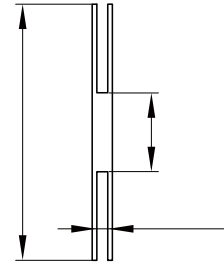
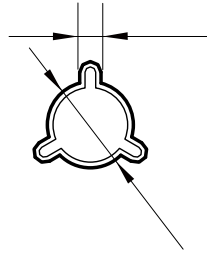
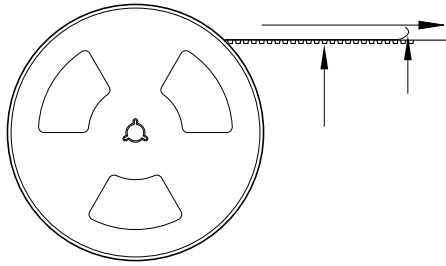

3000 Pcs/Reel

5 Reel /Inner box(15K Pcs)

8 Inner box/Carton box(120K Pcs)

:

-
-
-
-
-
-
-
-
-
-