

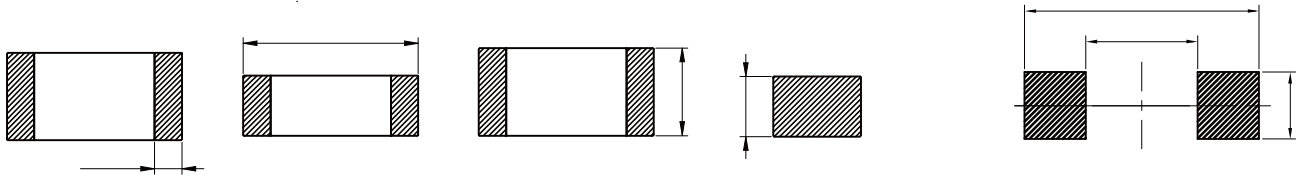

▪ Quantity: 3000pcs

▪



Part No	Z @ 100 MHz ( $\Omega$ )	Tolerance	R <sub>DC</sub> ( $\Omega$ )	I <sub>R</sub> (mA)
A1206-260-501R		%	0.20	500
A1206-310-501R		%	0.20	500
A1206-420-501R		%	0.20	500
A1206-500-501R		%	0.20	500
A1206-700-501R		%	0.20	500
A1206-900-501R		%	0.20	500
A1206-121-901R		%	0.15	900
A1206-151-901R		%	0.15	900
A1206-221-701R		%	0.35	700
A1206-301-701R		%	0.35	700
A1206-471		%	0.35	400
		%	0.40	400

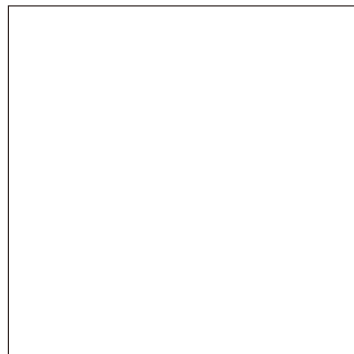
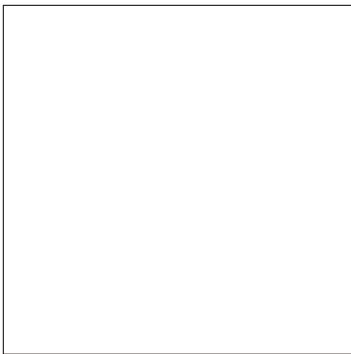
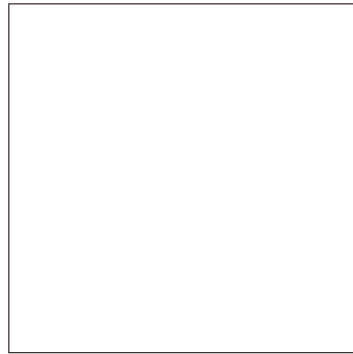
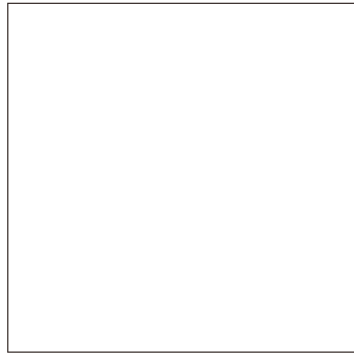
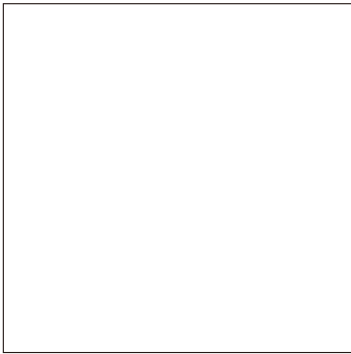
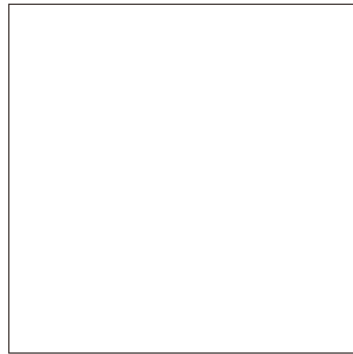
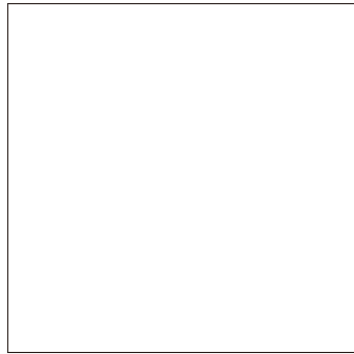
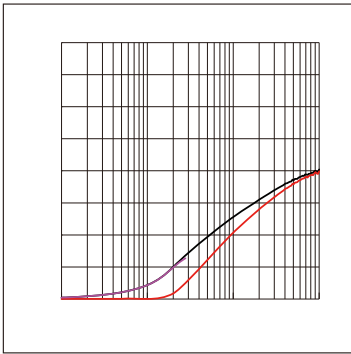

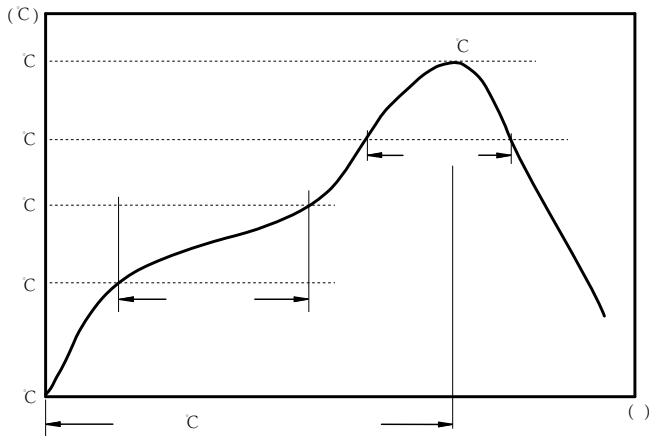

c  
c  
c

:

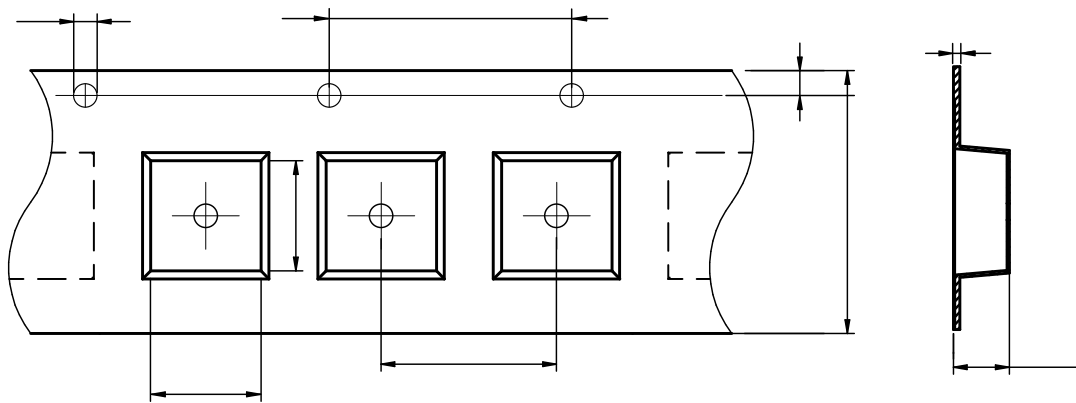

FBA1206	1.75±0.10	3.35±0.10	1.5±0.10	4.0±0.10	4.0±0.10	8.0±0.10	1.25±0.10	1.75±0.10	0.23±0.05
---------	-----------	-----------	----------	----------	----------	----------	-----------	-----------	-----------

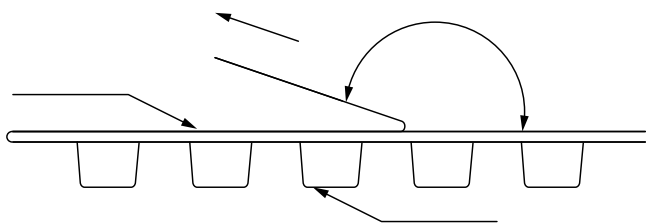

The peel force of top cover tape shall be between 0.14 to 0.58 N

:

