

MDA Series

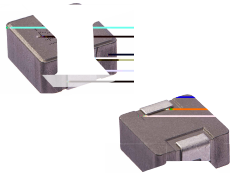

FEATURES

-
- Capable of corresponding high frequency .
- Low loss realized with low DCR.
- High performance (Isat) realized by metal dust core.
-
- 100% Lead(Pb)-Free and RoHS compliant.
-
-
-

APPLICATION

-
- HVAC
-
- Audio subsystem
- Digital instrument cluster
-

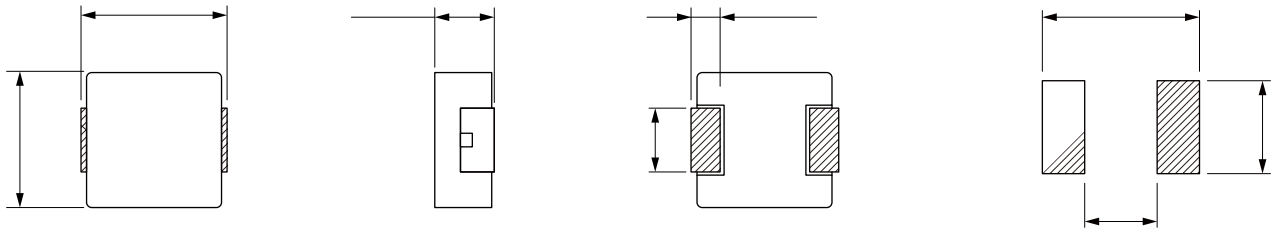

Part No	Inductance @ 100KHz/1V	Tolerance	Temperature Rise Current Typ. (A)	Temperature Rise Current Max. (A)	Current Typ. (A)	Current Max. (A)	DC Resistance Typ.	DC Resistance Max.	E
MDA1360-R36M	0.36	±20%	60.0	50.0	70.0	60.0	0.65	0.80	4.7±0.3
MDA1360-1R5M	1.50	±20%	28.0	24.0	32.0	27.0	2.40	3.00	4.0±0.3
MDA1360-2R2M	2.20	±20%	25.0	21.0	28.0	24.0	3.70	4.30	4.7±0.3
MDA1360-3R3M	3.30	±20%	21.0	18.0	28.0	24.0	5.30	6.50	4.7±0.3
MDA1360-4R7M	4.70	±20%	19.0	16.0	23.0	19.5	7.00	8.40	4.7±0.3
MDA1360-8R2M	8.20	±20%	13.5	12.0	17.0	15.5	13.5	16.0	4.7±0.3
MDA1360-100M	10.0	±20%	12.0	10.5	16.0	14.5	15.5	18.6	4.7±0.3
MDA1360-150M	15.0	±20%	10.0	8.5	10.0	9.0	24.0	29.0	4.7±0.3
MDA1360-220M	22.0	±20%	8.0	7.0	9.0	8.0	31.2	37.5	4.7±0.3
MDA1360-330M	33.0	±20%	6.5	5.5	7.8	6.7	56.0	68.0	4.7±0.3
MDA1360-470M	47.0	±20%	5.2	4.5	6.7	5.5	76.0	88.0	4.7±0.3



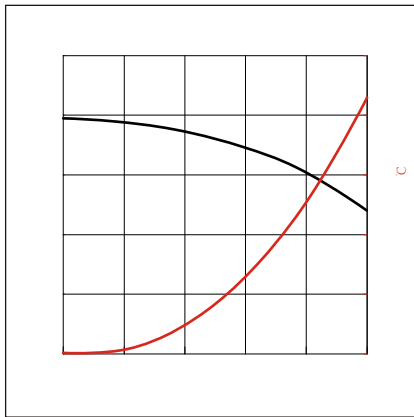
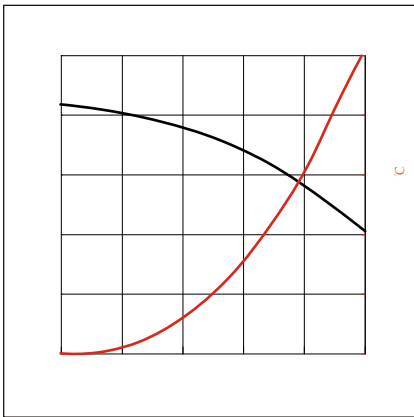
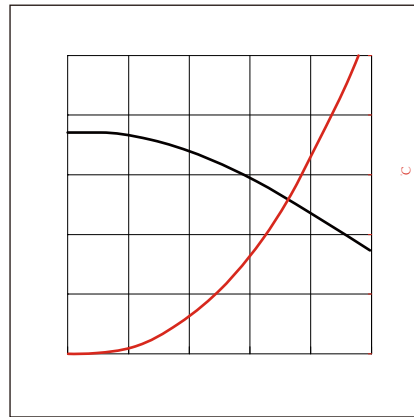
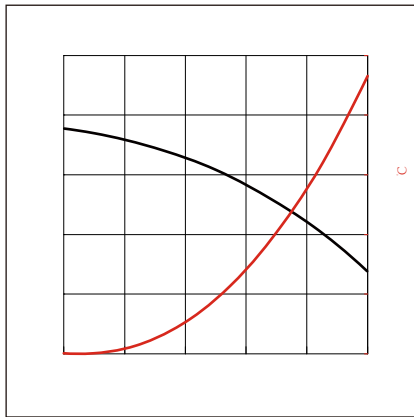
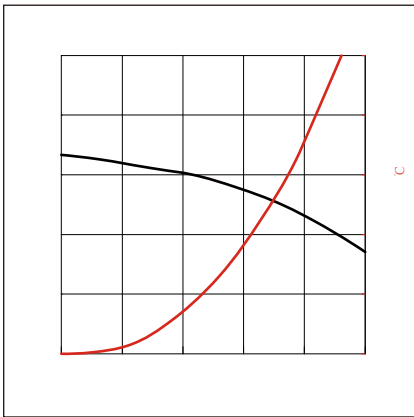
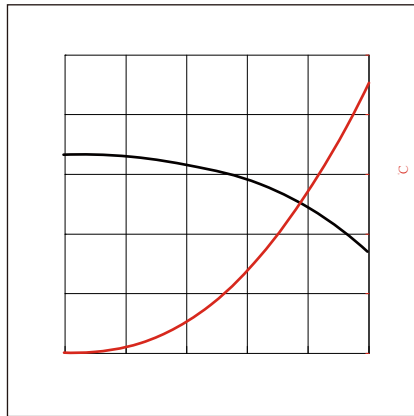
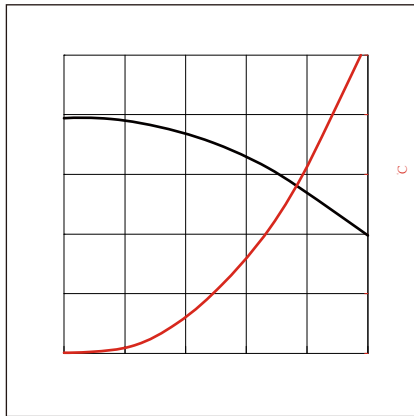
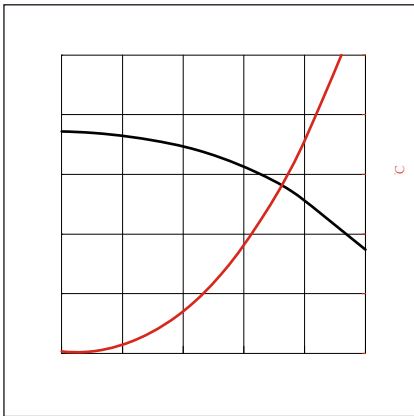
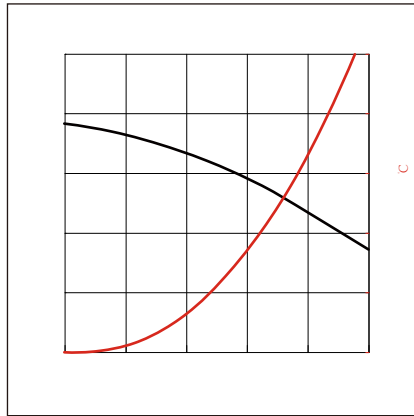
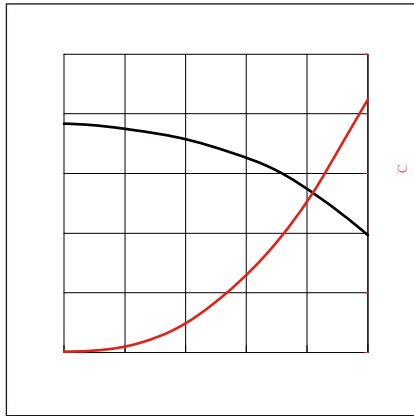
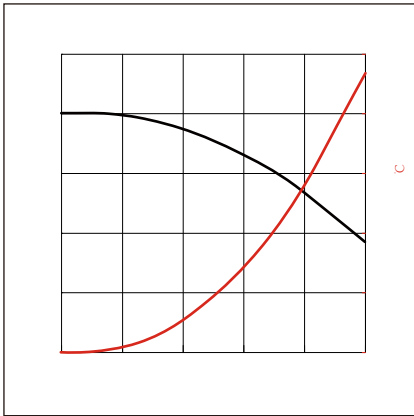

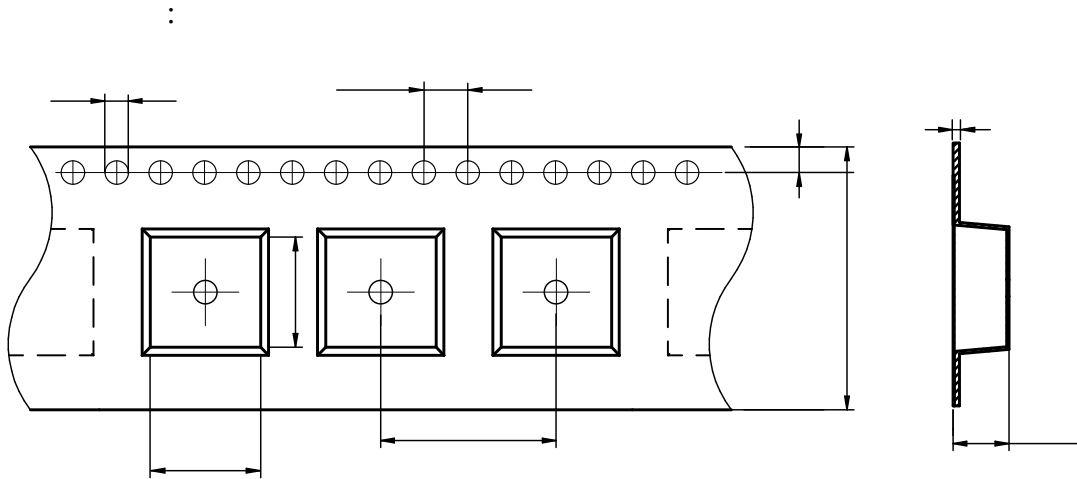
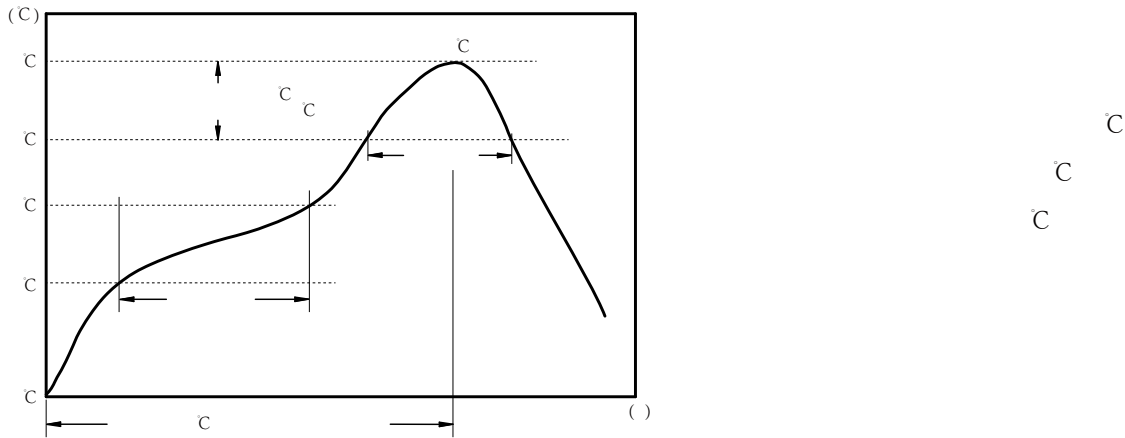

MDA1360	13.1±0.1	14.0±0.1	1.5±0.1	4.0±0.1	16.0±0.1	24.0±0.3	6.3±0.1	1.75±0.1	0.50±0.05
---------	----------	----------	---------	---------	----------	----------	---------	----------	-----------

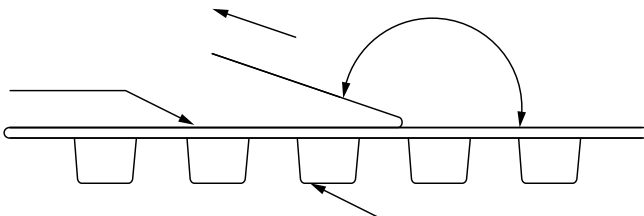

The peel force of top cover tape shall be between 0.1 to 1.3 N

Marking	KH+Printing (Inductance+period)
---------	---------------------------------

:

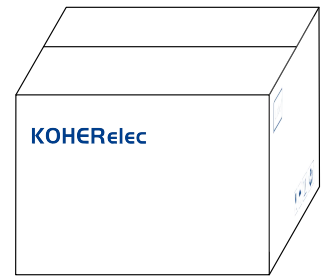
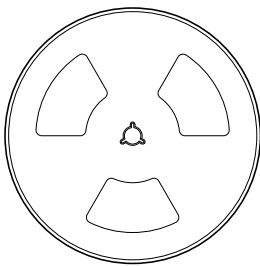
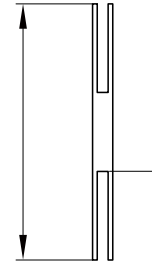
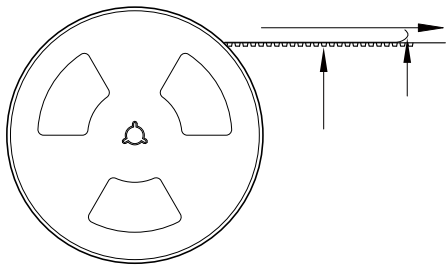

500 Pcs/Reel

2 Reel /Inner box(1000 Pcs)

2 Inner box/Carton box(2K Pcs)

:

-
-
-
-
-
-
-
-
-