

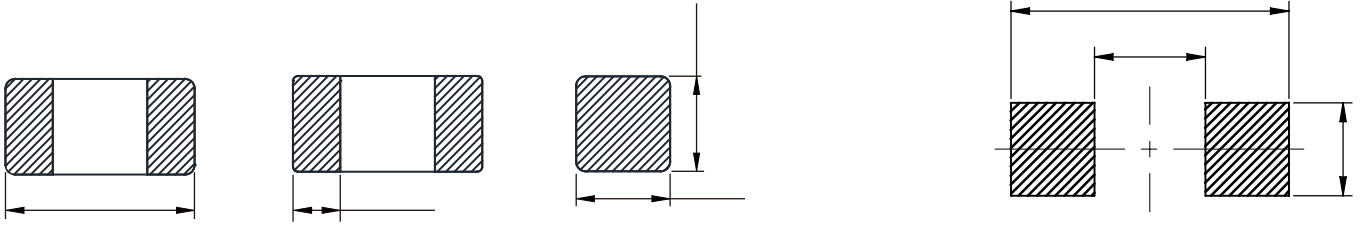

- 
- 
- 
- 
- 
- 
- 
- 



Part No	Impedance @ 100MHz ( )	Tolerance	DC Resistance Max. ( )	Rated Current Max. (mA)
FBHA0402-100-202R	10	±25%	0.100	2000
FBHA0402-100-252R	10	±25%	0.050	2500
FBHA0402-330-302R	33	±25%	0.022	3000
FBHA0402-600-252R	60	±25%	0.032	2500
FBHA0402-800-232R	80	±25%	0.038	2300
FBHA0402-121-202R	120	±25%	0.095	2000
FBHA0402-221-152R	220	±25%	0.150	1500

I<sub>R</sub>

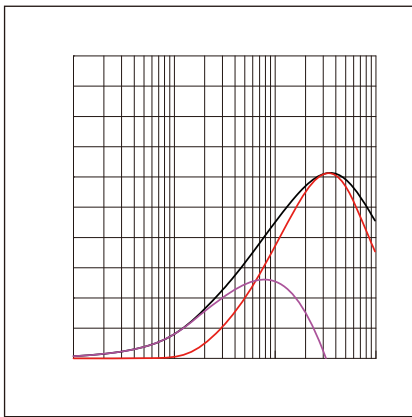
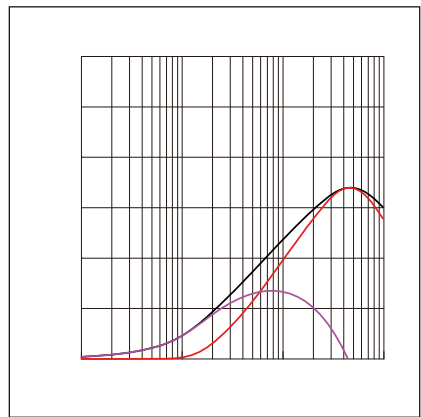
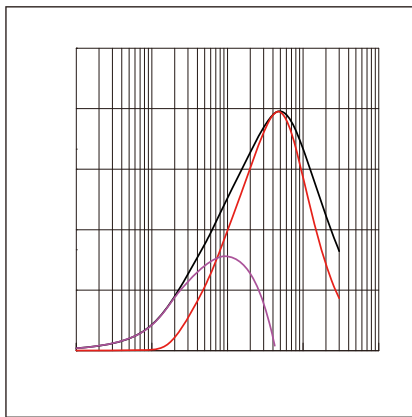
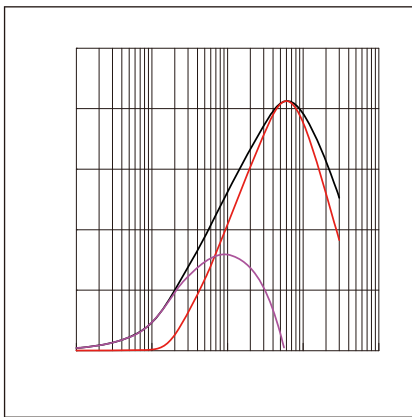
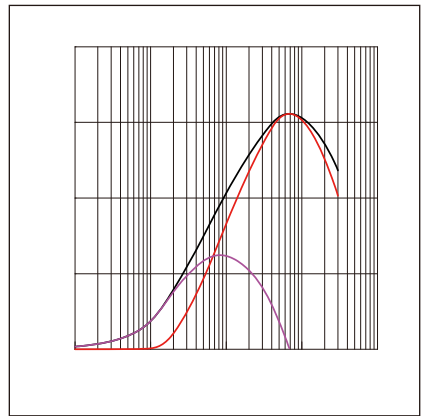
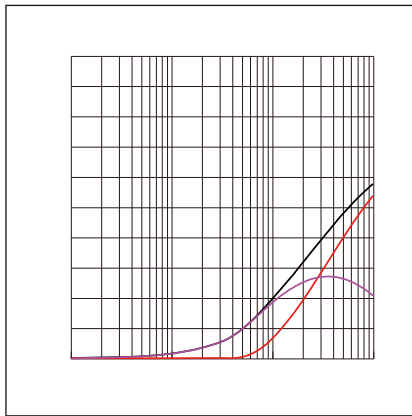
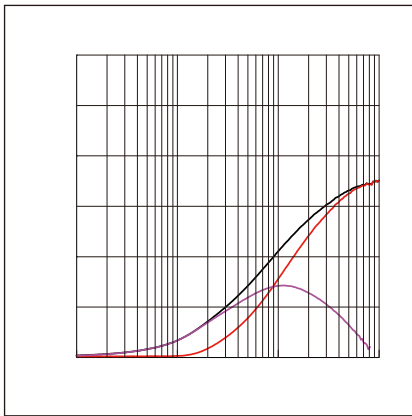

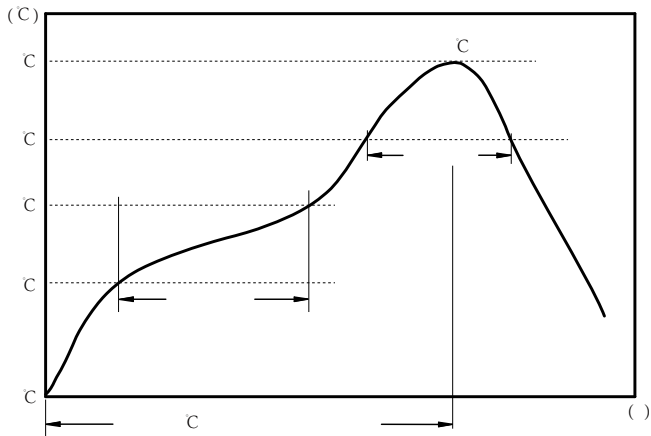

c  
c  
c

:

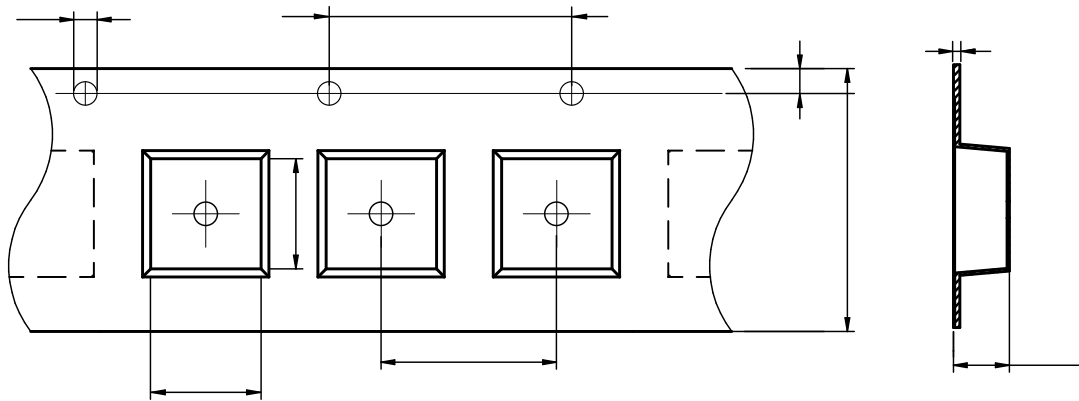

FBHA0402	0.62± 0.03	1.12± 0.03	1.5± 0.1	4.0± 0.1	2.0± 0.05	8.0± 0.3	0.60± 0.03	1.75± 0.1	0.60± 0.03

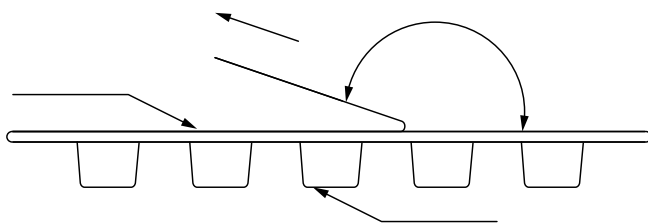

The peel force of top cover tape shall be between 0.14 to 0.58 N

:

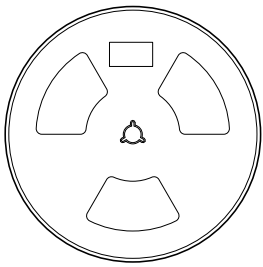
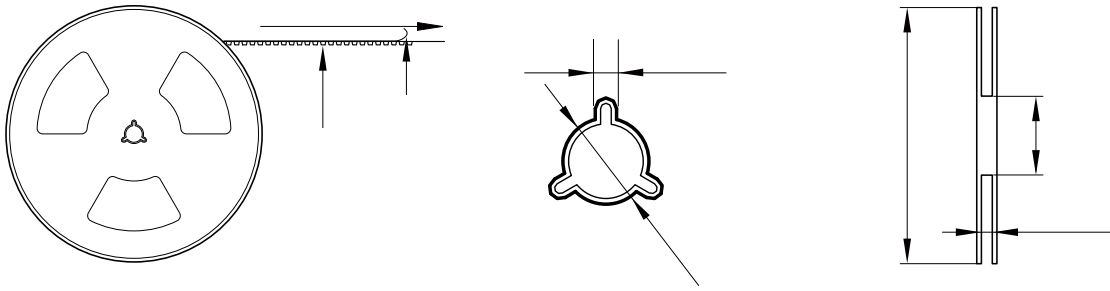

10000 Pcs/Reel

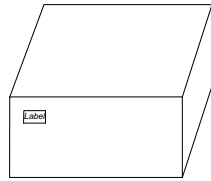

5 Reel /Inner box( 50K Pcs)

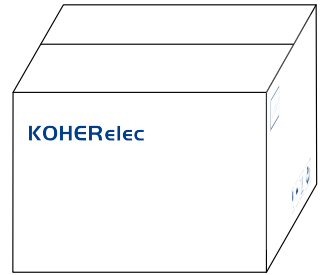

8 Inner box/Carton box(400K Pcs)

:

- 
- 
- 
- 
- 
- 
- 
- 
-